

# SHOWER SYSTEM

gerflor.com



**Gerflor**<sup>®</sup>  
theflooringgroup



# SHOWER SYSTEM

---

# 2019



**HYGIENE AND EASIER  
MAINTENANCE**



**DECORATIVE PRODUCTS**



**DURABLE AND WATERPROOF  
INSTALLATION**



**SAFETY FOR PATIENTS,  
RESIDENTS  
AND EMPLOYEES**



**ECO-FRIENDLY SOLUTION**

## **PRESENTATION OF THE RANGE \_\_\_\_\_ P. 4**

- ▶ A COMPLETE SOLUTION \_\_\_\_\_ p. 4
- ▶ BENEFITS OF THE SYSTEM \_\_\_\_\_ p. 8
- ▶ COLOR RANGE \_\_\_\_\_ p. 10

## **TECHNICAL SOLUTION & ACCESSORIES \_\_\_\_\_ P. 31**

- ▶ TECHNICAL INFORMATION ON COLORS \_\_\_\_\_ p. 31
- ▶ ACCESSORIES \_\_\_\_\_ p. 32
- ▶ SPECIFIC TOOLS \_\_\_\_\_ p. 34
- ▶ MAINTENANCE \_\_\_\_\_ p. 40
- ▶ PRODUCT DESCRIPTION \_\_\_\_\_ p. 42
- ▶ TECHNICAL DATASHEET \_\_\_\_\_ p. 44

## **SERVICES - ENVIRONMENT \_\_\_\_\_ P. 46**

- ▶ AN ECO-FRIENDLY SOLUTION \_\_\_\_\_ p. 48

A COMPLETE SOLUTION

# WALL COVERING



**MURAL CALYPSO**  
7002 Bamboo Lotus



**MURAL CALYPSO**  
7744 Nordic Milk

# FLOORINGS



**ELEGANCE SD**  
0322 Jicama



**TARASAFE STANDARD**  
7618 Edelweiss

# FOR WET AREAS



**MURAL CALYPSO**

7740 Fabric Silk

**MURAL CALYPSO**

7721 Manhattan Mist

**MURAL CALYPSO**

7003 Prism Ice

**MURAL CALYPSO**

7008 Fossil Ice

**MURAL CALYPSO**

7006 Blossom Haze Pearl



**TARASAFE GEO**

3771 Rock

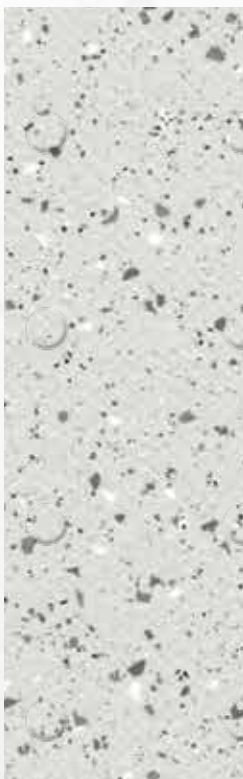

**TARASAFE ULTRA H2O**

7720 Iceberg

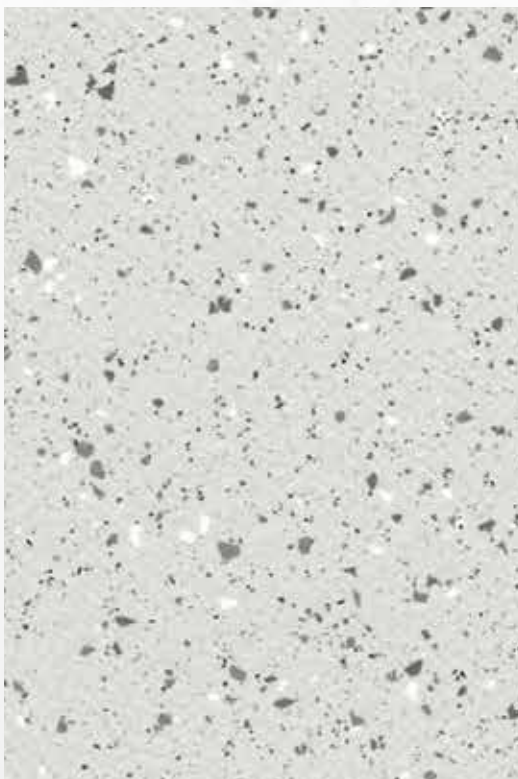

**TARASAFE ULTRA**

8701 Opal

# IDEAL FOR ALL APPLICATIONS



STUDENT  
ACCOMMODATION



HOSPITAL /  
CLINIC



ELDERLY  
PEOPLE  
HOME



HOTELS

HOUSING



LOCKERS

# BENEFITS OF THE SYSTEM



## **SAFETY** FOR PATIENTS, RESIDENTS AND EMPLOYEES

- **Compliance with barefoot and shod slip resistance norms** (DIN 51 097, DIN 51 130 and EN 13845)
- **Compliance with most "access to all" laws** (shower without tray)
- **Compliance with fire norm** EN 13501 and regulations for floorings and wall covering (B-s2,d0)





## HYGIENE AND EASIER MAINTENANCE

- Smooth and washable products
- Cove former and Gerflor Corner System for easier maintenance in angles: avoids pools of water forming
- Easy and economical maintenance
- Surface treatment on Tarasafe Ultra/Standard/Geo



## DECORATIVE PRODUCTS

- Attractive range of colors which enables more than **1600 combinations** between floors / wall to create calm, warm, Zen or light ambiances!
- Possibility to compose tone on tone surfaces without strong break between two floors especially for Alzheimer units thanks to the 3 colors of threshold
- Colour throughout the thickness for Mural Calypso to ensure a nice aspect of the welding (no white marks)



## DURABLE AND WATERPROOF INSTALLATION

- Complete solution with flooring-wall covering-accessories for a **100% waterproof** installation
- Hot welding on floor and wall coverings
- Floorings: 2 types of products > heterogeneous or homogeneous
- Vertical or horizontal installation for Mural Calypso
- Gerflor corner system for durability



## ECO-FRIENDLY SOLUTION

- 100% recyclable products
- Products manufactured in Europe in ISO 14001 certified factories
- Up to 50% of mineral or renewable material
- Recycled raw material 100% REACH compliant
- Low VOC emissions

Mural Calypso



7744 Nordic Milk

Mural Calypso



7740 Fabric Silk

Mural Calypso



7714 Frost

Mural Calypso

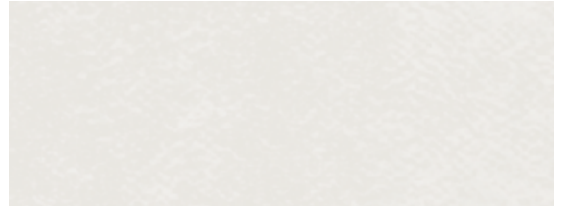

7711 Ice

Mural Calypso



7715 Crystal



WALL COVERING: MURAL CALYPSO  
FLOORING: TARALAY SÉCURITÉ

Elegance SD



0322 Jicama

Tarasafe Standard



7618 Edelweiss

Tarasafe Standard



7312 Dune

Tarasafe Geo



3303 Desert

Tarasafe Ultra

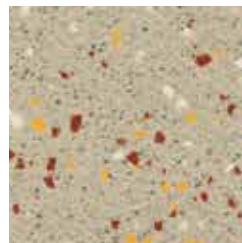

7384 Citrine

Tarasafe Geo



8081 Trail

**H<sub>2</sub>O** Tarasafe Ultra H2O - 7314 Sand

Mural Calypso



7712 Shadow

Tarasafe Ultra

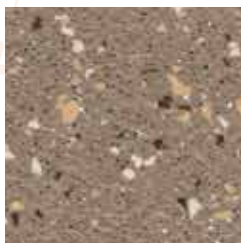

8013 Jasper

Elegance 5D



0329 Hazelnut

Mural Calypso



7002 Bamboo Lotus

Mural Calypso

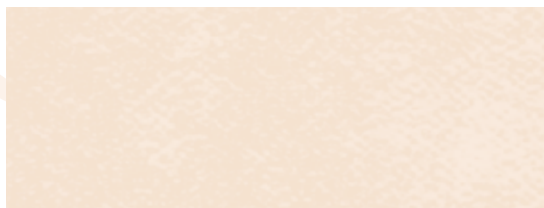

7309 Lotus

Mural Calypso

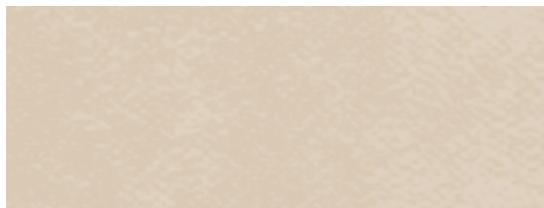

7311 Linen

Tarasafe Standard

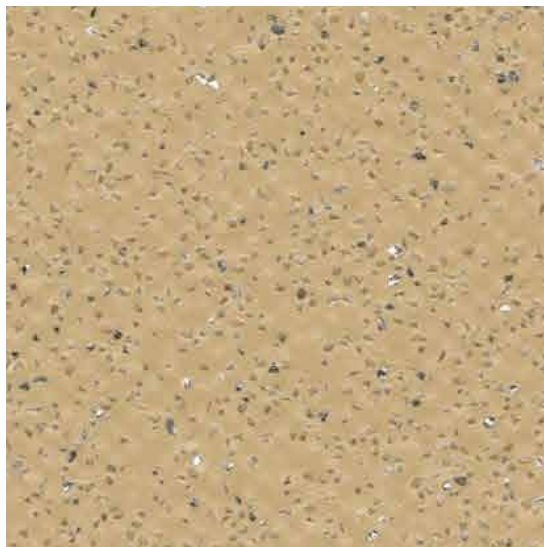

7302 Sahara

Mural Calypso



7006 Blossom Haze Pearl

Mural Calypso



7000 Bamboo Snow Pearl

Mural Calypso

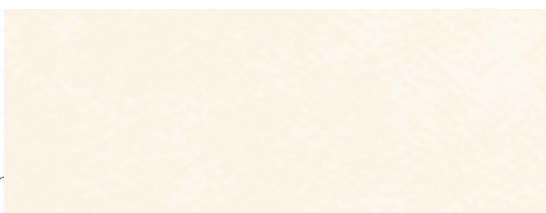

7611 Snow

Tarasafe Standard



7731 Marbre

Elegance SD

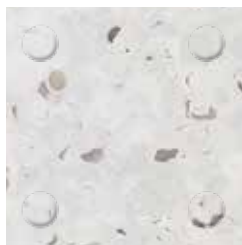

0705 Patisson

Tarasafe Ultra

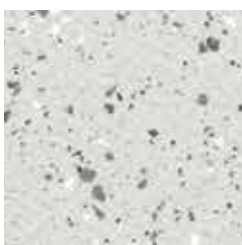

8701 Opal



Tarasafe Geo



3775 Crystalline

Mural Calypso



7005 Blossom Snow Pearl



WALL COVERING: BAMBOO SNOW PEARL  
FLOORING: ELEGANCE SD JICAMA

Mural Calypso



7736 Fabric Wool

Mural Calypso



7753 Nordic Zen

WALL COVERING: NORDIC ZEN

Presentation of the range

Tarasafe Ultra

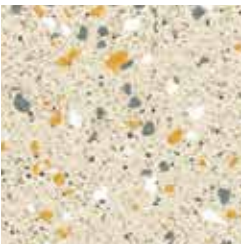

7383 Diopside



Tarasafe Geo



3772 Cliff

Tarasafe Standard



7386 Savana

Mural Calypso



7004 Prism Haze Pearl

Mural Calypso



7003 Prism Ice

Mural Calypso



7001 Bamboo Haze Pearl



WALL COVERING: PRISM HAZE PEARL

Elegance SD

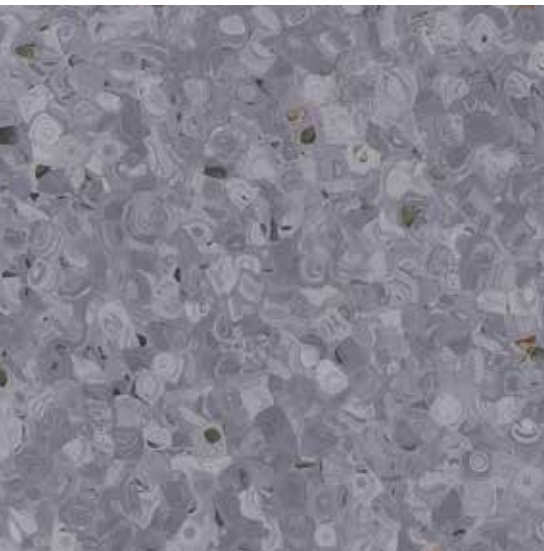

0704 Raspberry Grey

Tarasafe Ultra

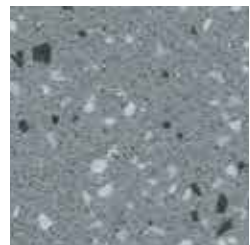

8709 Granite



Tarasafe Ultra

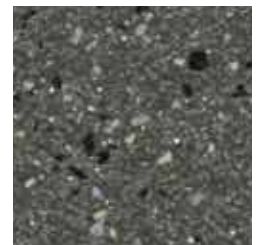

8710 Basalt

Tarasafe Standard



7801 Noir

Tarasafe Ultra

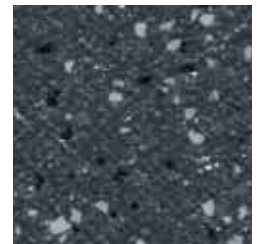

8717 Obsidian



 Tarasafe Ultra H2O - 7746 Stone / Tarasafe Ultra H2O - 7732 Gravel

Mural Calypso



7721 Manhattan Mist

Mural Calypso

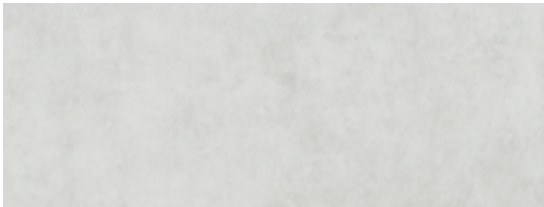

7010 Haze

Mural Calypso



7728 Manhattan Stone

Mural Calypso



7008 Fossil Ice

Mural Calypso



7009 Fossil Haze

Mural Calypso



7734 Manhattan Concrete

Tarasafe Ultra

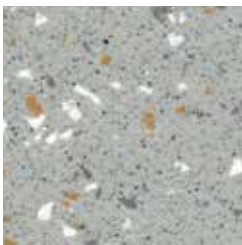

8704 Pebble

Tarasafe Standard



7773 Storm

Tarasafe Geo



3771 Rock

Tarasafe Standard

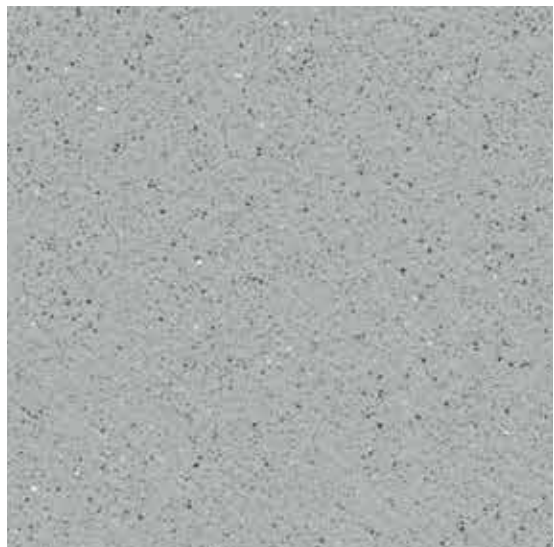

7767 Dove Grey

Mural Calypso



7007 Blossom Lichen

Mural Calypso



7011 Lichen

Tarasafe Geo

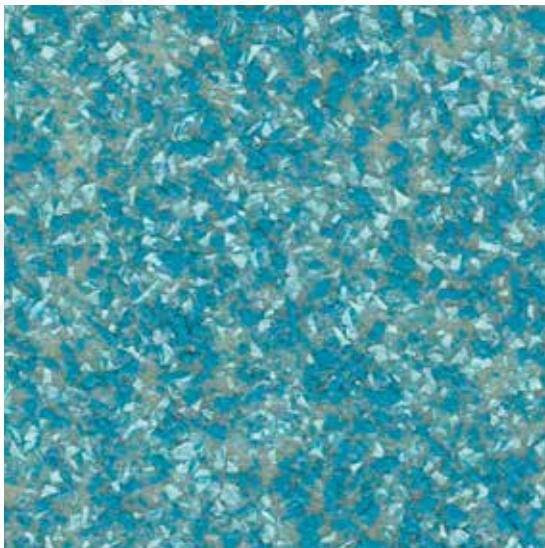

3405 Turquoise

Tarasafe Standard



7508 Avocado

Tarasafe Ultra

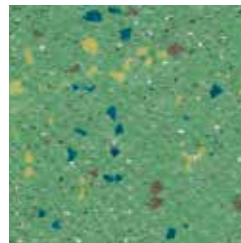

4508 Jade

Tarasafe Ultra

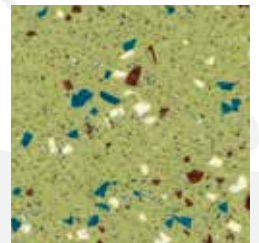

4505 Peridot

Tarasafe Ultra

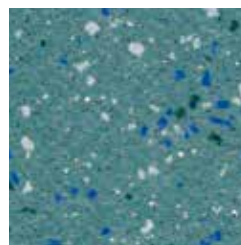

4460 Topaz

Tarasafe Ultra

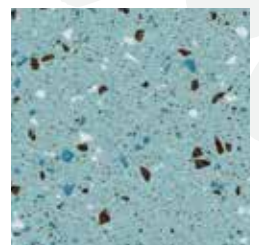

4463 Aqua

**H<sub>2</sub>O** Tarasafe Ultra H2O - 7513 Seagrass





FLOORING: MOONSTONE



Mural Calypso

7408 Skyline



Mural Calypso

7414 Fabric Denim



Mural Calypso

7012 Breeze

Tarasafe Ultra

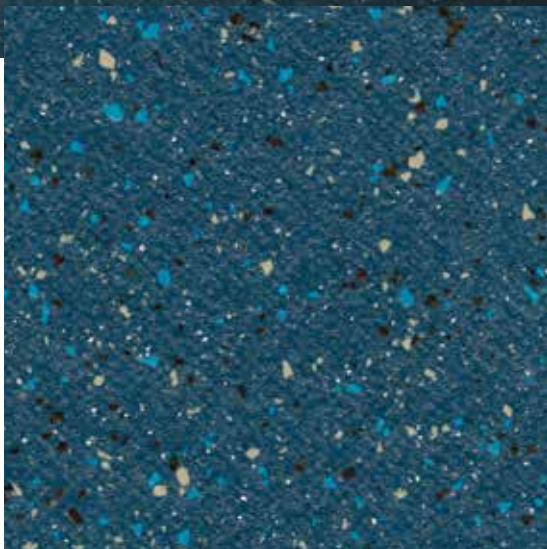

4472 Moonstone

Tarasafe Ultra

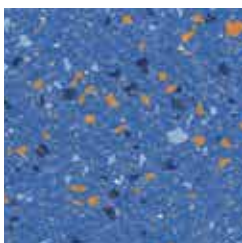

4470 Sapphire

Tarasafe Standard



7709 Royal Blue

Tarasafe Standard

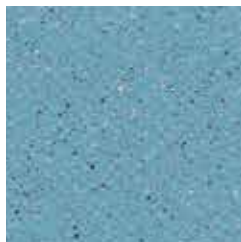

7704 Sky Blue

Tarasafe Standard



7438 Baleine

Elegance SD



0341 Bilberry

Tarasafe Ultra

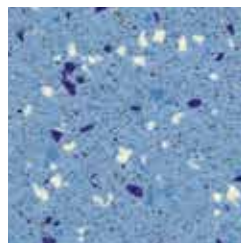

7482 Halite



Tarasafe Ultra

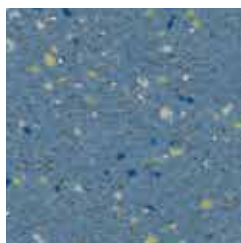

4465 Cobalt



Tarasafe Geo

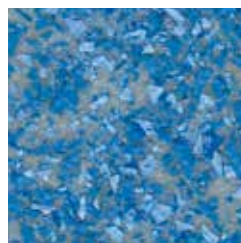

3409 Ocean Wave

**H2O** Tarasafe Ultra H2O - 7418 Marine / 7413 Ocean Blue

Mural Calypso



7201 Moonlight

Mural Calypso

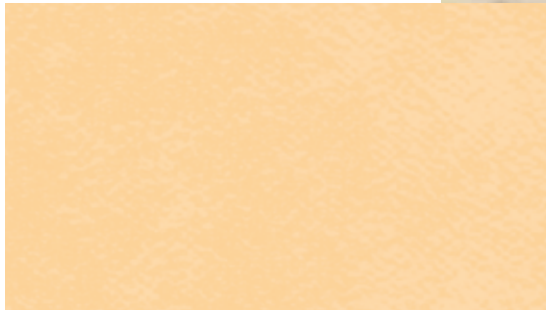

7104 Melon



FLOORING: TARALAY SÉCURITÉ SD ULTRA DIOPSIDE

Tarasafe Ultra

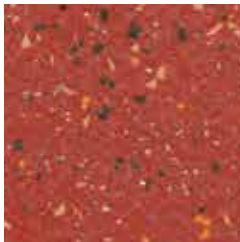

4128 Ruby

Tarasafe Standard



7107 Poppy

Tarasafe Geo

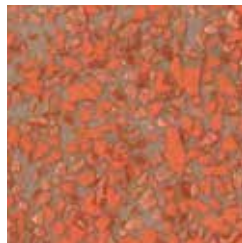

3105 Sunspot

Tarasafe Standard



7115 Flame

Elegance SD



0700 Melon

Tarasafe Ultra

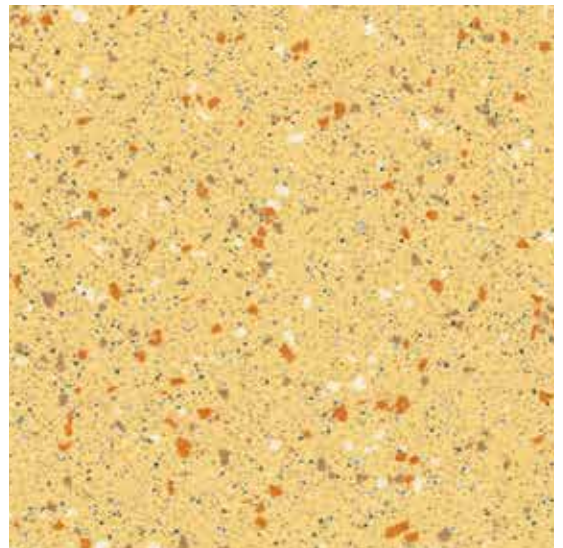

4323 Sandstone





# WALL COVERING COLOR RANGE

## MURAL CALYPSO

Compact | Bs2d0



7744 Nordic Milk



7002 Bamboo Lotus



7753 Nordic Zen



7000 Bamboo Snow Pearl



7734 Manhattan Concrete



7001 Bamboo Haze Pearl



7728 Manhattan Stone



7740 Fabric Silk



7721 Manhattan Mist



7736 Fabric Wool



7009 Fossil Haze



7414 Fabric Denim

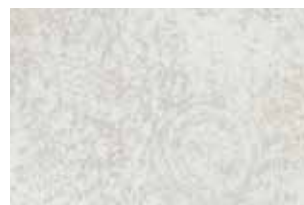

7008 Fossil Ice



7004 Prism Haze Pearl

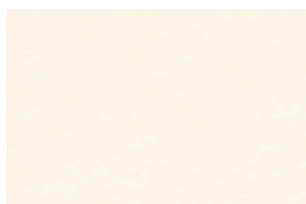

7611 Snow

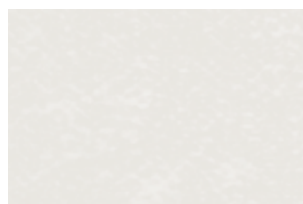

7711 Ice



7003 Prism Ice



7104 Melon



7715 Crystal



7005 Blossom Snow Pearl



7201 Moonlight



7714 Frost



7006 Blossom Haze Pearl

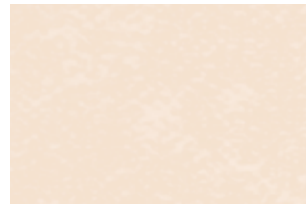

7309 Lotus

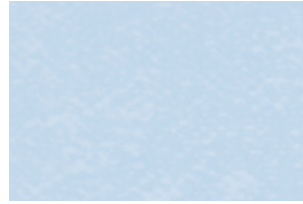

7408 Skyline



7007 Blossom Lichen



7311 Linen



7012 Breeze



7011 Lichen



7712 Shadow



7010 Haze

# FLOORING COLOR RANGE

## TARASAFE STANDARD



7386 Savana



7618 Edelweiss



7508 Avocado



7312 Dune



7731 Marbre

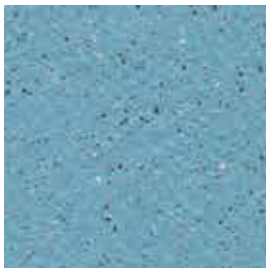

7704 Sky Blue



7302 Sahara



7767 Dove Grey



7438 Baleine



7115 Flame



7773 Storm

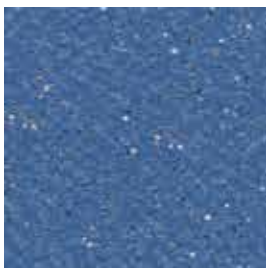

7709 Royal Blue



7107 Poppy



7801 Noir



# TARASAFE GEO



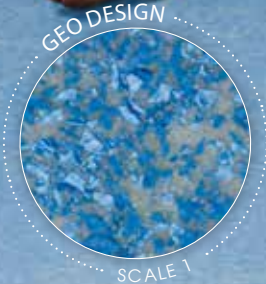

WALL COVERING: SKYLINE  
 FLOORING: OCEAN WAVE



3775 Crystal



3772 Cliff



3771 Rock



8081 Trail

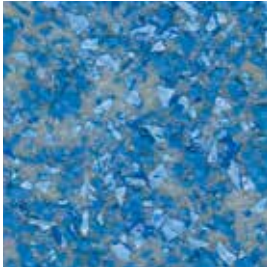

3409 Ocean Wave



3303 Desert

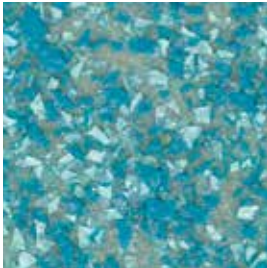

3405 Turquoise



3105 Sunspot





# FLOORING COLOR RANGE

## TARASAFE ULTRA

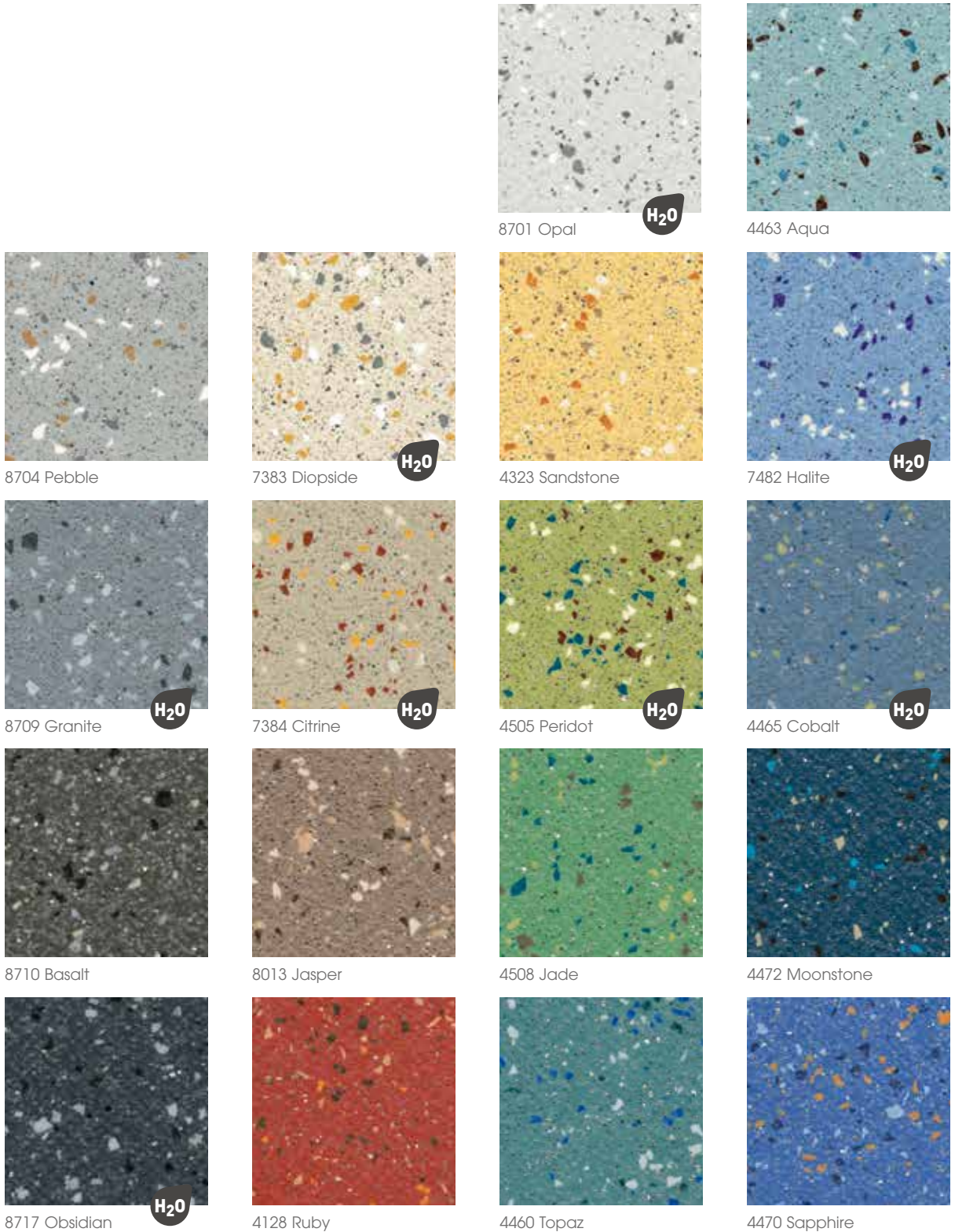

**H2O** Color reference available as Tarasafe Ultra H2O (R11)



# FLOORING COLOR RANGE

## TARASAFE ULTRA H2O

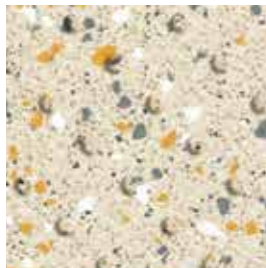

7325 Seashore

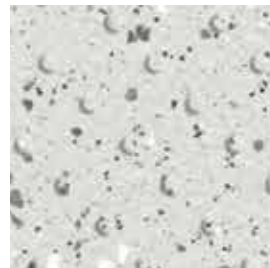

7720 Iceberg

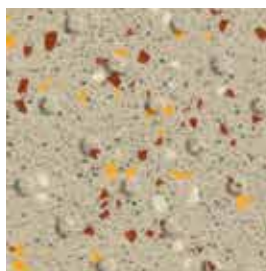

7314 Sand

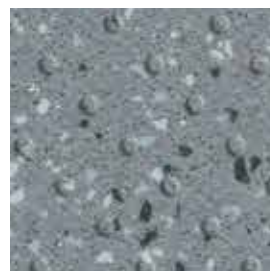

7746 Stone

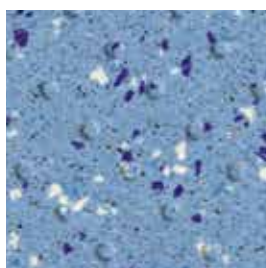

7413 Ocean Blue

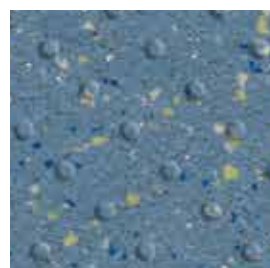

7418 Marine

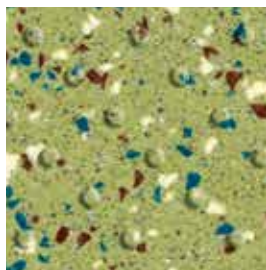

7513 Seagrass

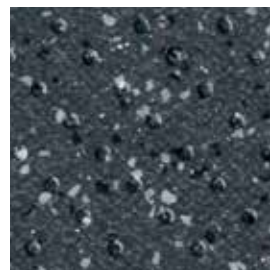

7732 Gravel



# ELEGANCE SD

Compact | B | R9



0322 Jicama



0705 Patisson



0329 Hazelnut



0704 Raspberry Grey



0700 Melon



0341 Bilberry



WALL COVERING: HAZE  
FLOORING: PATISSON



# TECHNICAL INFORMATION ON COLORS

COLORS	LRV Light Reflectance Value (Luminance)	NCS
--------	---	-----

## TARASAFE ULTRA

8701 Opal	59,1	1500-N
8709 Granite	25,4	5502-B
8717 Obsidian	10,1	7502-B
7383 Diopside	59,6	1005-Y20R
7482 Halite	32,5	2030-R80B
8013 Jasper	23,5	5010-Y50R
4128 Ruby	13,8	3560-Y80R
4323 Sandstone	51,5	1030-Y20R
4505 Peridot	35,5	3030-G70Y
4508 Jade	26,1	3040-G20Y
4460 Topaz	23,0	4020-B30G
8704 Pebble	44,1	3000-N
4463 Aqua	35,1	3010-B30G
4465 Cobalt	23,6	3030-R90B
4427 Moonstone	12,6	6020-R90B
7384 Citrine	40,2	3010-Y20R
8710 Basalt	11,9	7502-Y
4470 Sapphire	17,1	3050-R80B

## TARASAFE STANDARD

7618 Edelweiss	57,9	1505-Y10R
7773 Storm	21,3	5502-B
7801 Noir	5,7	9000-N
7312 Dune	45,8	3010-Y30R
7438 Baleine	21,4	4020-R90B
7508 Avocado	32,8	1510-Y40R
7107 Poppy	11,4	1580-R
7115 Flame	18,5	3050-Y70R
7767 Dove Grey	34,1	3502-G
7386 Savana	44,3	2005-Y50R
7731 Marbre	51,2	2002-B
7302 Sahara	35,1	3020-Y20R
7704 Sky blue	31,6	2030-B
7709 Royal blue	15,3	4040-R80B

## TARASAFE GEO

3772 Cliff	42,7	3005-Y20R
3775 Crystalline	38,9	3005-R80B
3771 Rock	31,3	3502-B
3405 Turquoise	30,9	3030-B30G
3303 Desert	44,1	3010-Y30R
3409 Ocean Wave	23,5	4030-R90B
3105 Sunspot	25,9	2050-Y70R
8081 Trail	33,0	4010-Y40R

COLORS	LRV Light Reflectance Value (Luminance)	NCS
--------	---	-----

## TARASAFE ULTRA H2O

7720 Iceberg	21,8	1002-B
7746 Stone	23,1	5502-B
7732 Gravel	9,2	7502-B
7325 Seashore	60,7	1005-Y20R
7418 Marine	31,2	3030-R90B
7413 Ocean Blue	22,9	4020-R90B
7513 Seagrass	36,0	3030-G60Y
7314 Sand	41,2	3010-Y10R

## ELEGANCE SD

0704 Raspberry Grey	20,3	5005-R80B
0341 Bilberry	34,8	2040-B10G
0329 Hazelnut	36,4	3010-Y40R
0700 Melon	48,2	1040-Y30R
0705 Patisson	64,4	1502-Y
0322 Jicama	67,8	1505-Y20R

## MURAL CALYPSO

7734 Manhattan Concrete	21,8	5500-N
7728 Manhattan Stone	39,5	3502-Y
7712 Shadow	40,7	3005-Y50R
7714 Frost	43,5	3000-N
7414 Fabric Denim	46,5	2020-R90B
7753 Nordic Zen	47,8	2502-Y
7736 Fabric Wool	49,4	2502-Y
7012 Breeze	55,7	1510-B20G
7311 Linen	56,5	1505-Y40R
7408 Skyline	56,8	1515-R90B
7740 Fabric Silk	58,8	1502-Y
7004 Prism Haze Pearl	60,2	1502-G50Y
7715 Crystal	60,6	1502-R
7104 Melon	61	1030-Y20R
7010 Haze	62,3	1502-G50Y
7009 Fossil Haze	62,7	1502-G50Y
7011 Lichen	62,8	1510-G20Y
7007 Blossom Lichen	63,8	1510-G20Y
7412 Manhattan Mist	64,6	1502-Y
7006 Blossom Haze Pearl	65,0	1502-G50Y
7001 Bamboo Haze Pearl	65,8	1502-G50Y
7008 Fossil Ice	67,4	1002-Y
7744 Nordic Milk	67,5	1502-Y
7003 Prism Ice	67,7	1502-Y
7201 Moonlight	70,5	0530-Y10R
7711 Ice	70,7	1002-G
7002 Bamboo Lotus	73,3	1005-Y20R
7309 Lotus	75,5	0804-Y30R
7005 Blossom Snow Pearl	75,6	0502-Y
7000 Bamboo Snow Pearl	80,2	0502-Y
7611 Snow	82,8	0502-G50Y

Information on welding rod available on [www.gerflor.com](http://www.gerflor.com)

# SHOWER SYSTEM

## FLOOR/WALL & ACCESSORIES SYSTEM FOR BATHROOM

### WALL ACCESSORIES

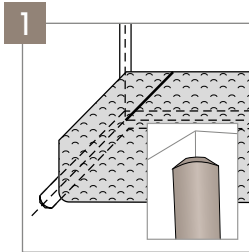

1  
Cove former for internal wall angles CA 12 - H204



2  
Perfect CR 41 wall weld - H231

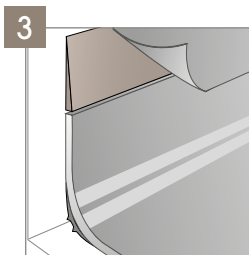

3  
Diminishing profile - 0490



6



## FLOORING ACCESSORIES

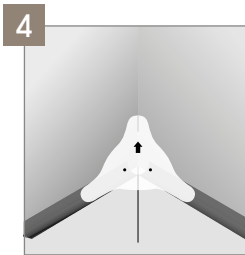

Clean Corner System IN  
058S

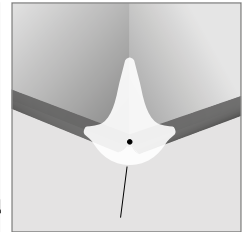

Clean Corner System OUT  
058R

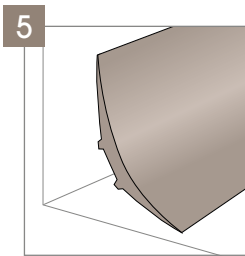

Cove former  
4011

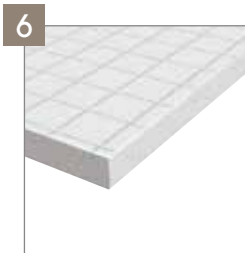

Tarafoam: acoustic insulation  
sublayer - 997C



PVC drain with inox grid -  
H090



Drains - H112 / H113  
SITAR / SITAR V



Shower threshold - 0469

The threshold has been developed in 3 colours: grey, beige and blue in order to answer to the specific requirement of Alzheimer units (no contrast).

- gris
- beige clair
- bleu

# ACCESSORIES

## PVC DRAINS

Description



PVC DRAIN WITH INOX GRID

H090



SITAR DRAIN

H112

SITAR V DRAIN



H113

Drains are made from white injected PVC.

**They enable:**

- ▶ Drainage of water
- ▶ Compatibility with the Shower System
- ▶ Complete watertightness by PVC/PVC bonding
- ▶ Fire rating NF-M1

Colours



001



001



001

Benefits

- ▶ Adjustable height (up to 85 mm with extension)
- ▶ For vertical exit (or horizontal when an elbow - not supplied - is fitted)
- ▶ Flow rate: 0,6 liter per second

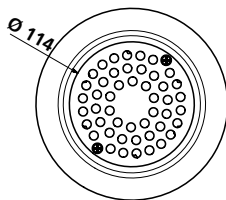
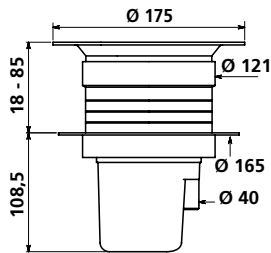

- ▶ An adjustable ring depending on the screeds
- ▶ Height adjustment
- ▶ **2 outlets (horizontal and vertical)** allow for flexibility on site
- ▶ 50 mm trap seal

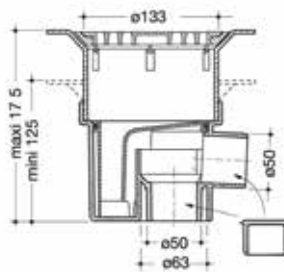

Packaging Unit

- ▶ **Integral drain with vertical drainage**
- ▶ 50 mm trap seal

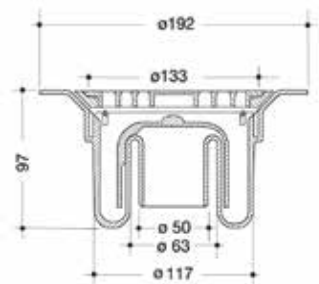

Packaging Unit

Tips

- The floor covering is filled into the gully to a watertight seal.



# ACCESSORIES

## COVE FORMER FOR INTERNAL ANGLES

## TARAFOAM

Description

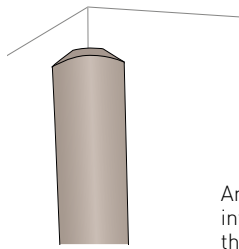

CA12

Angle bead to be placed in the internal angles before installing the wall covering

H204



COMFORT VERSION OF THE SHOWER SYSTEM

997C 6792

Colours



0719

Benefits

- ▶ Eliminates potential puncture damage to internal corners
- ▶ Size: 12 mm

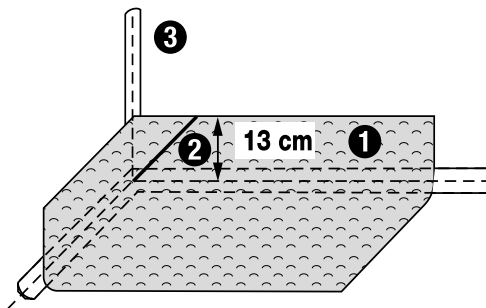

- 1 Cove the floor up to a height of 130 mm.
- 2 Cut the floor covering at 45° and weld the CR 40 rod.
- 3 Wall angle: double bonding of the CA 12 to the entire height.

**Packaging**  
1 x 50 lm coil

- ▶ Provides **acoustic insulation for the shower system** and comfort under foot.
- ▶ Thickness: 2mm.

**Packaging**  
Roll of 2 m x 20 lm

Tips

- Levels out around the edge of the room.
- Acrylic bonding.
- Edge to edge installation.

# ACCESSORIES

## CLEAN CORNER SYSTEM IN

## CLEAN CORNER SYSTEM OUT

Description

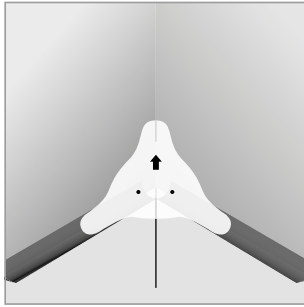

CLEAN  
CORNER  
SYSTEM IN

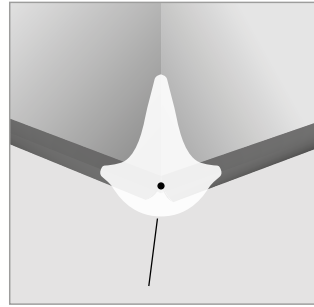

CLEAN  
CORNER  
SYSTEM OUT

058S

058R

Colours



0001



0001

Benefits

- ▶ **Neat and uniform design** on all corners
- ▶ **Easy and quick cleaning** and decontamination



196 x 176 mm

**Packaging**  
60 units per box



110 x 108 mm

**Packaging**  
20 units per box

Tips

- Installation instructions available on [www.gerflor.com](http://www.gerflor.com)

## PVC WALL COVERING/COVING JUNCTION

## COVE FORMER

Description

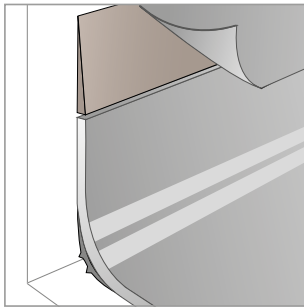

### DIMINISHING PROFILE

Coving/wall covering connection

Used in laboratories, hospital shower systems, commercial kitchens

0490

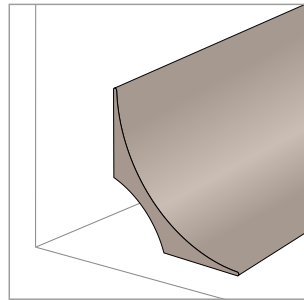

### PVC COVE FORMER

This accessory allows the floor-wall cove to be formed

4011

Colours



6512



6512

Benefits

- ▶ Makes it easier to link the floor covering and wall
- ▶ **Hygienic.** Avoids bacteria accumulation
- ▶ **Prevents** the floor covering from **tearing**, improves **durability** and ensures **watertightness**.

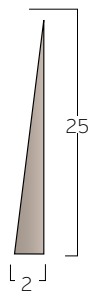

**Packaging**  
2 x 25 lm rolls

- ▶ Enables coving and allows **watertightness**
- ▶ Its rounded shape **makes it easier to clean** the floor/wall junction
- ▶ Offers a better look
- ▶ Limits the risk of piercing the floor covering
- ▶ **Prevents accumulation** of bacteria.

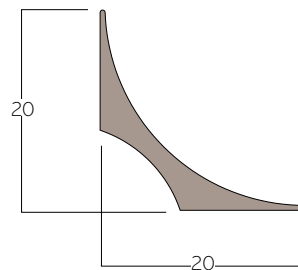

**Packaging**  
30 x 2 lm strips

Tips

- Bond with acrylic adhesive

- Only a single 45° angle is cut
- Double bonding (polychloropene type)
- Use a miter shear for a perfect cut

# ACCESSORIES

## PVC SHOWER THRESHOLD PROFILE

Description

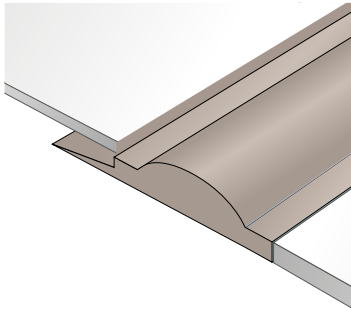

PVC SHOWER THRESHOLD PROFILE

Makes the junction between a floor covering and a shower covering

0469

Colours

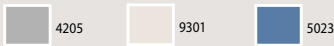

Benefits

- ▶ Allows welding of 2 mm or 3.5 mm floor covering thanks to the tab system
- ▶ Weld system with the covering which ensures perfect watertightness

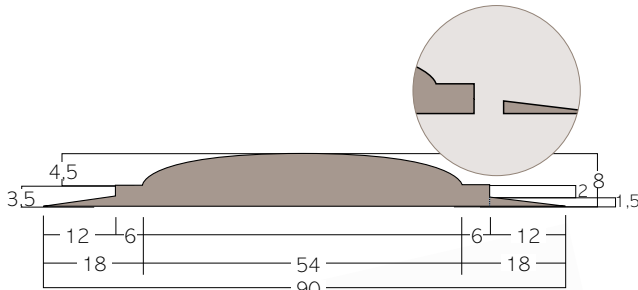

### Packaging

10 x 3 lm strips

Tips

- The tab can be cut to suit a thicker floor
- Polychloroprene double bonding
- Application of sealant around the door jamb (PU or MS polymer sealant)

## DECOCHOC PANNEL

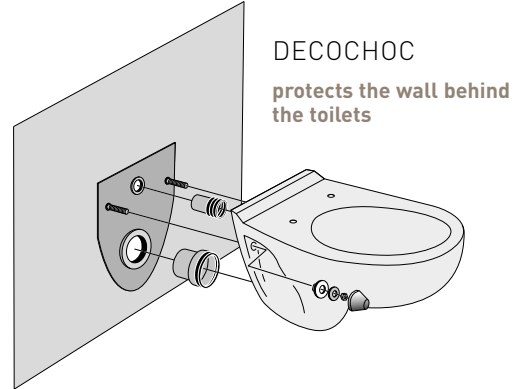

DECOCHOC

protects the wall behind the toilets

For more information, contact SPM.

- ▶ Prevents blisters on the wallcovering at the junction of the toilets

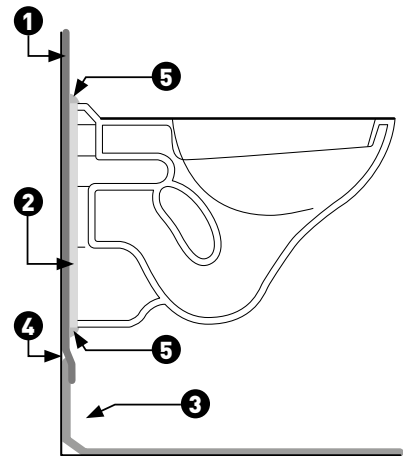

- 1 Gerflor wallcovering product
- 2 Decochoc
- 3 Flooring with 13cm cove form
- 4 Diminishing profile
- 5 Mastic

- Installation instructions available on [www.gerflor.com](http://www.gerflor.com)



# SPECIFIC TOOLS

## LIST OF SPECIFIC TOOLS

### ROMUS

e-mail : commercial@romus.fr

### JANSER S.A.

LIST OF SPECIFIC TOOLS

### WOLFF

www.wolff.fr

	ROMUS	JANSER	WOLFF
TRACER FOR COVING - 200 mm substrate bead	Ref. 95430	Ref. 222 430 100	
ADHESIVE SPATULA WITH INTERCHANGEABLE BLADE (18 CM)			
A 2 BLADE TKB STANDARD			
A 4 BLADE TKB STANDARD			
PRESSURE ROLLER - steel Ø 30 x 45 mm		Ref. 224 400 125	Ref. 111 200 000
COVING RULER - For cutting flooring 13 cm and 10 cm from the floor, for coving		Ref. 224 432 000	
CORK BLOCK FOR BONDING	Ref. 93145	Ref. 262 380 000	Ref. 720 930 000
COMBINED TRACER AND MARKING GAUGE - (spur 1 mm thick)	Ref. 09335	Ref. 262 130 500	
SPARE BLADE (in 5s)	Ref. 93356	Ref. 262 415 001	
SPARE POINT Ø 1,5 mm (in 20s)	Ref. 93357	Ref. 262 126 000	
ROLLER FOR INTERNAL ANGLE	Ref. 093135	Ref. 224 400 123	Ref. 116 340 000
ROLLER FOR EXTERNAL ANGLE		Ref. 262 614 000	Ref. 116 350 000
COVING FINISHING TOOL			
HOT CHAMFERING GOUGE FOR TARASFE			
ULTRA FAST NOZZLE		Ref. 224 800 007	
SPEED NOZZLE WITH BLOW HOLES	Ref. 95030	Ref. 224 700 300	
TRIANGULAR SCRAPER with interchangeable blade	Ref. 95185	Ref. 262 607 000	Ref. 721 030 000
SPARE BLADE		Ref. 262 627 001	Ref. 721 031 000
FINISHING SPATULA - For finishing flooring with projections		Ref. 262 609 100	Ref. 116 400 000 Ref. 116 402 000
PRESSURE BALL - Brass - Ø 13 mm - For rounding joints in angles		Ref. 224 816 000	Ref. 116 200 000
ROUNDED BALDE Ø 4 mm - For sharpening finishing spatulas and cleaning nozzles	Ref. 95191	Ref. 262 609 102	







## ACCESSORIES AVAILABLE FROM GERFLOR (SEE PAGES 32-38)

## OTHER RECOMMENDED ACCESSORIES, NOT AVAILABLE FROM GERFLOR

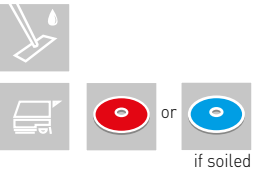
**MASTIC** - BOSTIK SA - Ref. : POLYMER MS107 de BOSTIK

# MAINTENANCE

## SHOWER SYSTEM FLOORINGS





	Equipment used	Cleaning products	Cleaning methods
<b>FLOORS</b>	<b>First use</b> <b>Manual cleaning</b> 	Alkaline detergent alcalin	<ul style="list-style-type: none"> <li>• Damp sweeping</li> <li>• Manual cleaning with a scrubbing brush</li> <li>• Recovery of soiled water with a flat mop                             <ul style="list-style-type: none"> <li>• Rinsing with clean water</li> <li>• Let the floor dry</li> </ul> </li> </ul>
	<b>Mechanical cleaning</b>  if soiled		
<b>FLOORS</b>	<b>Daily cleaning</b> <b>Manual cleaning</b> 	Neutral detergent Disinfectant detergent <sup>(1)</sup>	<ul style="list-style-type: none"> <li>• Damp sweeping</li> <li>• Manual washing with flat mop                             <ul style="list-style-type: none"> <li>• Rinsing</li> <li>• Let the floor dry</li> </ul> </li> </ul>
	<b>Mechanical cleaning</b> 		
<b>FLOORS</b>	<b>Deep cleaning</b> <b>Manual cleaning</b> 	Alkaline detergent	<ul style="list-style-type: none"> <li>• Damp sweeping</li> <li>• Manual cleaning with a scrubbing brush</li> <li>• Recovery of soiled water with a flat mop                             <ul style="list-style-type: none"> <li>• Rinsing with clean water</li> <li>• Let the floor dry</li> </ul> </li> </ul>
	<b>Mechanical cleaning</b> 		
<b>WALLS <sup>(2)</sup></b>	<b>Cleaning of walls</b> 	Neutral detergent	<ul style="list-style-type: none"> <li>• Wall washing</li> <li>• Rinsing</li> <li>• Let the floor dry</li> </ul>

(1) In areas where disinfection is essential (e.g. operating theatres, hospital rooms, etc.), alternate between using neutral detergent and amine-free disinfectant detergent.

(2) For further informations, please refer below.

For safety reasons (slipperiness), hygiene and to preserve the appearance of the product, in time, take care not to leave stagnant water or wet objects (mop, broom ...) and dry well between each maintenance.

## WALL COVERING MURAL CALYPSO

	Equipment used	Cleaning products	Cleaning methods
<b>First use</b>	 mop	Alkaline detergent	<ul style="list-style-type: none"> <li>• Manual cleaning with an alkaline detergent + a microfibre disposable mop</li> <li>• Recovery of water with a microfibre disposable mop</li> <li>• Rinsing with clear water</li> </ul>
<b>Daily cleaning</b> Once a day	 mop	Neutral detergent for areas 1 and 2 + Disinfectant detergent (amine-free) for areas 3 and 4	<ul style="list-style-type: none"> <li>• Manual cleaning with a mop or</li> <li>• Steam cleaning</li> </ul>
<b>Periodical cleaning</b> Once a month and at patient's departure in areas 1 and 2 Once a week and at patient's departure in areas 3 and 4	 mop	Alkaline detergent or disinfectant detergent (amine-free)	<ul style="list-style-type: none"> <li>• Cleaning with a mop + alkaline detergent                             <ul style="list-style-type: none"> <li>• Rinsing with clear water</li> </ul> </li> <li>• Disinfect with disinfectant detergent (amine-free) or</li> <li>• Steam cleaning (if manual daily maintenance)</li> </ul>
<b>Deep cleaning</b> Once a month	 mop	Alkaline detergent	<ul style="list-style-type: none"> <li>• Manual cleaning with an alkaline detergent + a mop</li> <li>• Rinsing with clear water</li> </ul>

These cleaning instructions have to be adapted depending on traffic and location of the area.

### ⚠ ATTENTION, FOR PVC FLOORS AND WALLS CLEANING:

Do not use disinfectant detergents used to clean ceramics, toilets and sinks for PVC coatings. Also, do not allow the rinsing water of these products to flow on shower PVC floors and walls covering because they contain certain amines causing yellowing of PVC coverings.

## MURAL CALYPSO

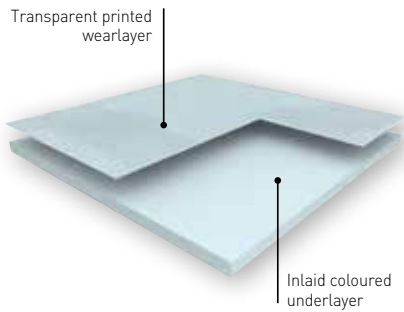

## ELEGANCE SD

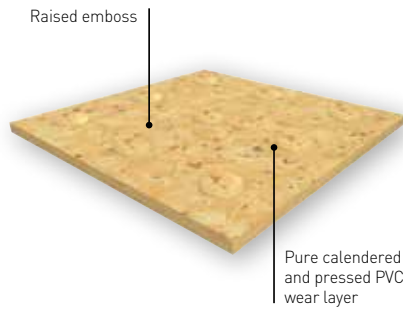

## TARASAFE ULTRA & GEO

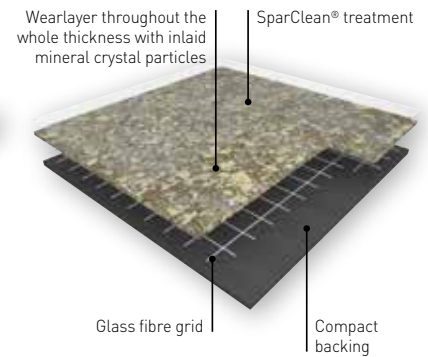

## MURAL CALYPSO

**MURAL CALYPSO** is a multilayered wall covering in 2m width roll and with a **B-s2,d0 fire classification** according to EN 13501.

It is hot welded with CR41 welding rods for a perfect water tightness.

It is made of a printed transparent wear layer and a **coloured** under layer for a better aspect of the welding. This layer comprises up to 30% of recycled products.

It does not contain any CMR 1 & 2 component and is 100% compliant with REACH.

It is 100% recyclable.

This wall covering is specially recommended for wet room areas and makes the installation in angles easier thanks to its flexibility.

The Shower System is compliant with most laws on "access for all" thanks to the installation in shower without tray.

## ELEGANCE SD

**ELEGANCE SD** is a flexible homogeneous calendared compacted floorcovering available in 2 m sheet, with a non-directional polychrome design, to offer an even colour throughout the thickness. It should be hot welded with a CR 40 welding rod for a perfect watertightness.

**ELEGANCE SD** is specifically embossed for wet barefoot traffic.

**ELEGANCE SD** is compliant with antislip resistance norms (R9 according to DIN 51130 and B classification according to DIN 51097) for a **safe usage** in barefoot or shod applications such as showers. The Shower System enables access for all in showers especially for disabled people.

It is made of 32% mineral material and 34% renewable material. It uses 100% controlled recycled material. The TVOC emissions in the air at 28 days (EN 16000) are < 10 µg / m<sup>3</sup>. It is 100% recyclable.

## TARASAFE ULTRA & GEO

**TARASAFE ULTRA and GEO** is a slip resistant vinyl floor-covering, with a PVC wear layer and deeply inlaid mineral particles and coloured chips for a decorative design and better slip resistance.

**TARASAFE ULTRA and GEO** is an ideal solution for traffic applications where enhanced slip resistance and durability are required. The mineral particles gives a Class B barefoot slip resistance (DIN 51 097) and R10 shod slip resistance (DIN 51 130).

It is reinforced with a glass fibre grid in sheet form. Its homogeneous wear layer provides a group T of abrasion.

It is treated with **SparClean®** surface treatment, a low maintenance cost effective solution providing extreme resistance from soiling and staining.

It does not contain any heavy metals or CMR 1&2 and it is 100% compliant with REACH. The product emission rate of volatile organic compounds is < 100 µg/m<sup>3</sup> (TVOC after 28 days – ISO 16000 -6). This product is 100%.



## TARASAFE STANDARD

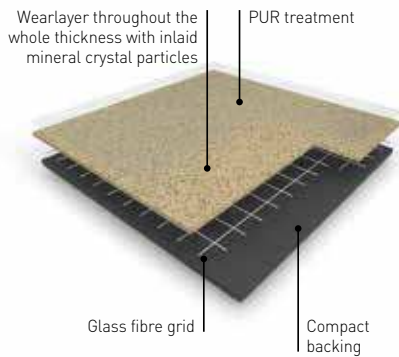

## TARASAFE ULTRA H2O

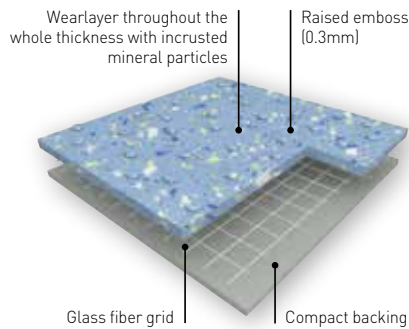

### TARASAFE STANDARD

**TARASAFE STANDARD**, with **PUR** surface treatment is a slip resistant safety vinyl floorcovering, with a PVC wear layer and deeply inlaid mineral crystal particles (patented). It is reinforced by a glass fibre grid and available in a sheet format. It is an ideal solution for **heavy traffic applications** where slip resistance, durability, hygiene and easy maintenance are required. The mineral particles gives a Class B barefoot slip resistance (DIN 51 097) and R10 shod slip resistance (DIN 51 130).

**TARASAFE STANDARD**, is suitable for most contract & commercial areas. It is eco-friendly, 100% recyclable, Floorscore® certified and does not contain any heavy metals or CMR 1&2, it is also 100% compliant with REACH. The product emission rate of volatile organic compounds is < 100 µg/m<sup>3</sup> (TVOC after 28 days – ISO 16000 -6). The **PUR** surface treatment improves the product performance in term of stain resistance and durability.

### TARASAFE ULTRA H2O

**TARASAFE ULTRA H2O** is a slip resistant vinyl floorcovering, with a PVC wear layer and deeply inlaid mineral particles and coloured chips for a decorative design together with a raised emboss for better slip resistance.

**TARASAFE ULTRA H2O** is an ideal solution for traffic applications where enhanced slip resistance with barefoot and durability are required such as wet areas. The specific embossing together with the mineral particles gives a Class C barefoot slip resistance (DIN 51 097) and R11 shod slip resistance (DIN 51 130) which makes **TARASAFE ULTRA H2O** ideal for barefoot or shod applications.









It is reinforced with a glass fibre grid in sheet form. Its homogeneous wear layer provides a group P of abrasion.

It does not contain any heavy metals or CMR 1&2 and it is 100% compliant with REACH. The product emission rate of volatile organic compounds is < 100 µg/m<sup>3</sup> (TVOC after 28 days – ISO 16000 -6). This product is 100% recyclable and contents 18% of mineral material and 22% of inexhaustible material.

# TECHNICAL DATASHEET

			MURAL CALYPSO	ELEGANCE SD	TARASAFE	
					Geo	Ultra
<b>DESCRIPTION</b>						
Total thickness	EN ISO 24346	mm	0.92	2.4 (on grainside)	2	
Thickness of wearlayer	EN ISO 24340	mm	0.10	2.4	1.00	0.85
Weight	EN ISO 23997	g/m <sup>2</sup>	1610	3100	2370	2460
Width of sheet	EN ISO 24341	cm	200	200	200	
Length of sheet	EN ISO 24341	ml	30	20	20	
<b>CLASSIFICATION</b>						
Product specification	-	-	EN 15102	EN ISO 10581	EN ISO 10582	
European classification	<b>EN ISO 10874</b>	class	-	<b>34 - 43</b>	<b>34 - 43</b>	
Fire rating	EN 13 501-1	class	Bs2,d0	Bfl-s1	Bfl-s1	
Static electrical propensity	EN 1815	kV	-	< 2	< 2	
Slip resistance wet	DIN 51 097 (barefoot)	class	-	B	B	
	DIN 51 130 (ramp test with oil)		-	R9	R10	
Determination of slip resistance – wbarefoot & shod + water	EN 13845-annexe C	class	-	-	ESf - ESb	
Water tightness	EN 13553	-	-	OK	OK	
<b>PERFORMANCES</b>						
Wear resistance	EN 660.2	mm <sup>3</sup>	-	≤ 4.0	≤ 2.0	
Wear group	(EN 649)	group	-	P	T	
Type Binder content	ISO 10582	type	-	-	I	
	ISO 10581		-	I	-	
Dimensional stability	EN ISO 23999	%	-	≤ 0.40	≤ 0.40	
Impact sound Insulation	EN ISO 717-2	dB	-	-	6	
TARAFOAM Impact sound Insulation	EN ISO 717-2	dB	-	-	16	
Residual indentation [requirement]	EN ISO 24343-1	mm	-	≤ 0.10	≤ 0.10	
Residual indentation (measure)	EN ISO 24343-1	mm	-	~ 0.03	~ 0.03	
Thermal conductivity	EN ISO 10456	W/(m.K)	-	0.25	0.25	
Colour fastness	EN 20 105 - B02	degree	≥ 6	≥ 6	≥ 6	
Chemical resistance	EN ISO 26987	class	OK	OK	OK	
Surface treatment	-	-	-	-	SparClean®	
Anti-bacterial activity [E. coli – S. aureus – MRSA] <sup>(1)</sup>	ISO 22196	-	> 99% inhibits growth	-	> 99% inhibits growth	
<b>ENVIRONMENT / INDOOR AIR QUALITY</b>						
TVOC after 28 days	ISO 16001	µg / m <sup>3</sup>	-	<10	<100	
Certification	-	-	-	Floorscore®	Floorscore®	
<b>CE MARKING</b>						
<b>CE</b>	EN 15102	-	OK	-	-	
	EN 14041	-	-	-		

(1) The implementation of an effective cleaning method is the best defence against infection.

TARASAFE ULTRA H2O	
Standard	Ultra
2	2 (on grainside)
0.85	1.00
2460	2400
200	200
20	20
EN ISO 10582	EN ISO 10582
34 - 43	34 - 43
Bfl-s1	Cfl-s1
< 2	< 2
B	C
R10	R11
ESf - ESb	ESf-ESb
OK	In progress
≤ 2.0	≤ 4.0
T	P
I	I
-	-
≤ 0.40	≤ 0.40
6	-
16	17
≤ 0.10	≤ 0.10
~ 0.03	~ 0.03
0.25	0.25
≥ 6	≥ 6
OK	OK
PUR	-
> 99% inhibits growth	> 99% inhibits growth
<100	<100
Floorscore®	Floorscore®
-	
   	   





MURAL CALYPSO DESIGN  
SCALE 1

# GERFLOR SERVICES

## PARTNER FOR ALL YOUR PROJECTS!

### A TRAINING CENTER AVAILABLE FOR ALL

Dedicated to both vocational training for young people and continuing training of professionals.

### A TECHNICAL ASSISTANCE

A technical team moves on your construction sites in order to support you in situ.

### A KNOWN EXPERTISE

Take the advantage of our expertise and build together a global solution for your project.

### A LARGE PALETTE OF ACCESSORIES



Handrails



Wall Coverings & Protections



Entrance mats



Skirtings & Profiles



### ONLINE SERVICES

Access to all our services on our website



#### WELDING RODS MATCHING

<https://www.gerflor.com/services-pro/welding-rods.html>



#### VIRTUAL LIBRARY

Access to our documentation on line  
<https://www.gerflor.com/services-pro/virtual-library-pro.html>

#### ROOM VISUALIZER "INTERIOR DESIGNER"

##### New Interior designer

Choose a picture or upload the picture of your own project, select a Gerflor floor and visualize in few clicks the results!

<http://interiordesignerpro.gerflor.com>



# GERFLOR, AN ECO-RESPONSIBLE CHOICE



**TVOC < 100µg/m<sup>3</sup>**  
after 28 jours



## COMPOSITION

- 100% REACH compliant
- FREE of formaldehyde
- FREE of heavy metals
- FREE of solvent



## INSTALLATION

- Innovative adhesive free installation systems



## RECYCLED CONTENT

- 25% average recycled content
- 100% REACH compliant recycled content



## RECYCLING

- 100% recyclable product



## LIFE CYCLE ANALYSIS

- Eco-designed according to a product specific Life Cycle Analysis
- Product specific EPD (Environmental Products Declaration) available
- Manufactured in an ISO 14001 and ISO 50001 certified site
- Contribution to many Green Building Schemes (LEED, HQE, BREEAM...)
- Exclusive surface treatments to reduce drastically the use of chemical product and water and ensure the lowest environmental impact



## INDOOR AIR QUALITY

- TVOC emissions 10 times better than norms requirements (TVOC < 100 µg/m<sup>3</sup> after 28 days)
- TVOC < 10µg/m<sup>3</sup> after 28 days for all products treated Evercare™ / ProtecSol<sup>2</sup>
- Floorscore certified
- M1 certified
- Comply with AgBB protocol
- No formaldehyde emission



## WELLNESS

- Health: Antibacterial activity (inhibits growth > 99%)
- Safety: Anti slip performance
- Comfort: Walking comfort and impact noise reduction

# OFFCUTS RECYCLING

## GERFLOR SECOND LIFE PROGRAM



100%  
Recyclable



### RECYCLING "CLEAN" OFFCUTS:

(PRODUCTION AND INSTALLATION OFFCUTS, FLOORS WITHOUT ADHESIVE, OLD STOCK)

Gerflor has set up different programs to collect and recycle production and installation offcuts of PVC floors, and incorporate them into the production of new floors. Gerflor has created Floor to Floor, **a joint-venture with the leading recycling company Paprec**, with the target to recycle 5,000 t/year. With the Second Life program, Gerflor collects also offcuts from floors installers.



### RECYCLING "GLUED" OFFCUTS:

(FLOORS WITH ADHESIVE, END-OF-LIFE FLOORS)

Together with the professional federations, Gerflor propose to installers the collection of end-of-life floors and their recycling in a specialised recycling center, where PVC is extracted and introduced into other PVC-based products such as road traffic cones, pipes for construction...

For more information, please contact your Gerflor Sales Representative or send an e-mail to our specialist: [secondevie@gerflor.com](mailto:secondevie@gerflor.com)







**GERFLOR INTERNATIONAL**

Tel: +33 (0)4 74 05 40 00

Fax: +33 (0)4 74 05 03 13

e-mail: gerflorcontract@gerflor.com

gerflor.com

**ARCHITECTURE  
DECORATION  
SPORT  
TECHNOSPECIFIC**

**Gerflor** Don't forget our complementary ranges!



Handrails



Wall Coverings  
& Protections



Entrance mats



Skirtings  
& Profiles

**Be connected!**



www.gerflor.com

**#Gerflor**

RC Lyon B 726 580 152 - JPE - 09/2020 - Z004 4239

**SHOWER SYSTEM, AN ECO-RESPONSIBLE CHOICE**



**COMPOSITION**  
100% REACH



**RECYCLABLE**  
100%



**INDOOR  
AIR QUALITY**  
100 times better than  
norms requirements  
(TVOC < 10ug/m³ after  
28 days)



**LCA**  
Eco-designed according  
to a product specific Life  
Cycle Analysis



**WELLNESS**  
Safety: Anti slip  
performance